

Wózek narzędziowy z wyposażeniem

Model: GW-08807(W/4) / GV-27909(W/7) – 367 sztuk narzędzi

W/4-Drawer Tool Chest - 88PCS Contents

1ST DRAWER

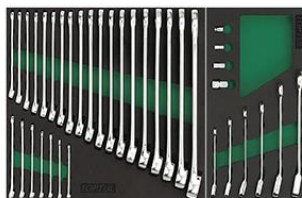

GVC2604 GVA1017

2ND DRAWER



GVC1202 GVA1103

3RD DRAWER



GVA0711 GVA0410 GVA0716

4TH DRAWER

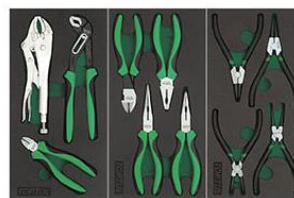

GVA0301 GVA0405 GVA0406



W/7-Drawer Tool Trolley - 279PCS Contents

1ST DRAWER

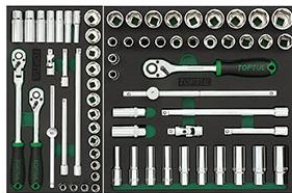

GVA3002 GVC3903

2ND DRAWER

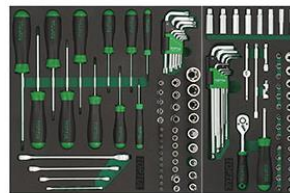

GVC6101 GVA5004

3RD DRAWER



GVB2503 GVB1202

4TH DRAWER



GVB0904 GVB0701

5TH DRAWER



GVD4602

Kliknij na wybraną wkładkę i znajdź indywidualne narzędzie.

Indeks: GV-27909+88



Item no.	Content / Zawartość	Size [mm]	Zam./Order
GVC2604	26	AAEW0606	6
		AAEW0707	7
		AAEW0808	8
		AAEW0909	9
		AAEW1010	10
		AAEW1111	11
		AAEW1212	12
		AAEW1313	13
		AAEW1414	14
		AAEW1515	15
		AAEW1616	16
		AAEW1717	17
		AAEW1818	18
		AAEW1919	19
		AAEW2020	20
		AAEW2121	21
		AAEW2222	22
		AAEW2323	23
		AAEW2424	24
		AAEW2525	25
		AAEW2626	26
		AAEW2727	27
		AAEW2828	28
		AAEW2929	29
		AAEW3030	30
		AAEW3232	32

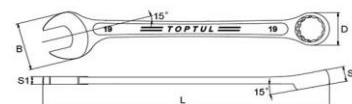
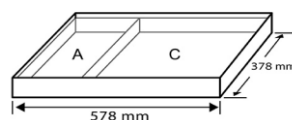
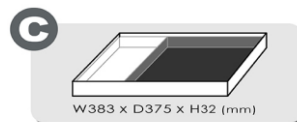



Item no.	Content / Zawartość	Size [mm]		L [mm]	Tooth	Zam./Order		
GVA1017	6	ABAF0808	8	-	140	72		
		ABAF1010	10	-	158	72		
		ABAF1212	12	-	171	72		
		ABAF1313	13	-	178	72		
		ABAF1717	17	-	225	72		
		ABAF1919	19	-	247	72		
	3	CANA0810	10	●	1/4" ■	-	-	
		CANA1213	13	●	3/8" ■	-	-	
		CANA1619	19	●	1/2" ■	-	-	
	1	FTAB0810	10	●	1/4" ○	-	-	

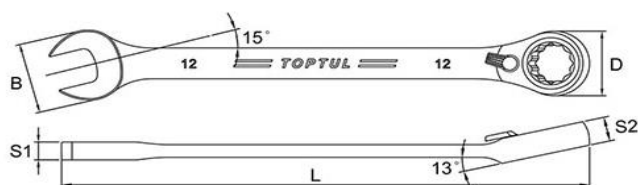
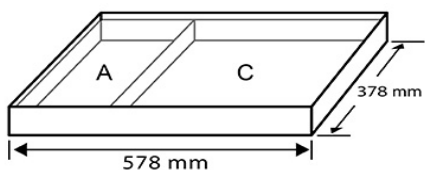
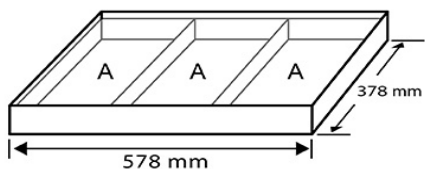
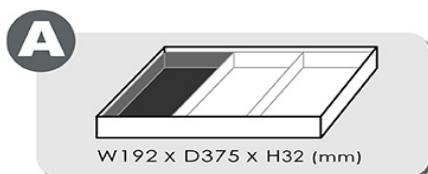
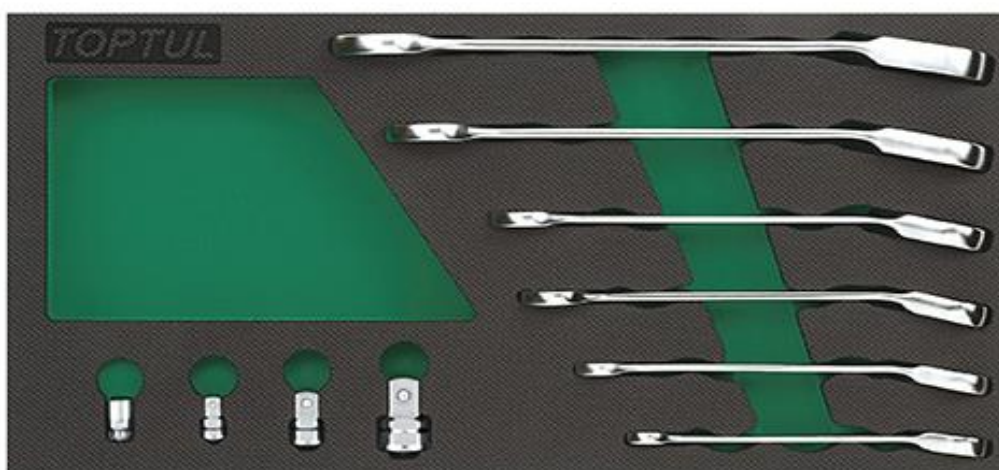



Item no.	Content / Zawartość	Size [mm]	L [mm]	Zam./Order	
GVC1202	12	AAEI0607	6x7	167	
		AAEI0809	8x9	182	
		AAEI1011	10x11	197	
		AAEI1213	12x13	218	
		AAEI1415	14x15	238	
		AAEI1617	16x17	258	
		AAEI1819	18x19	290	
		AAEI2022	20x22	316	
		AAEI2123	21x23	316	
		AAEI2427	24x27	328	
		AAEI2528	25x28	345	
		AAEI3032	30x32	360	

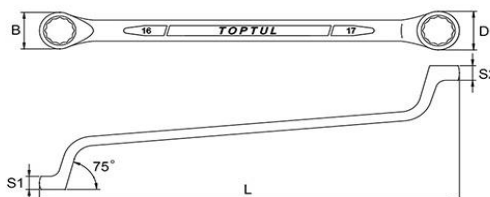
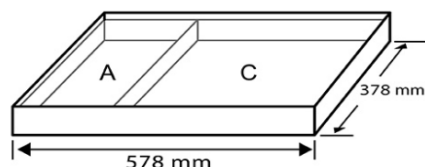
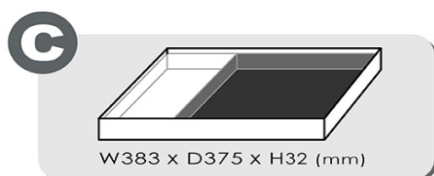



Item no.	Content / Zawartość	Size [mm]	L [mm]	Zam./Order	
GVA1103	11	AAEJ0607	6x7	127	
		AAEJ0809	8x9	145	
		AAEJ1011	10x11	161	
		AAEJ1213	12x13	174	
		AAEJ1415	14x15	190	
		AAEJ1617	16x17	210	
		AAEJ1819	18x19	223	
		AAEJ2022	20x22	236	
		AAEJ2123	21x23	316	
		AAEJ2427	24x27	267	
		AAEJ3032	30x32	294	

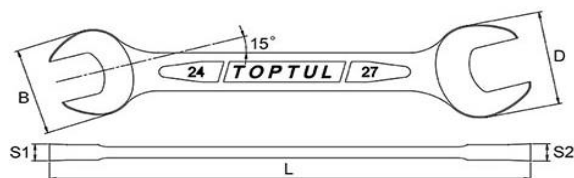
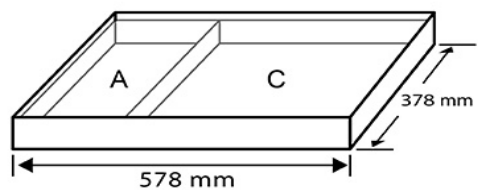
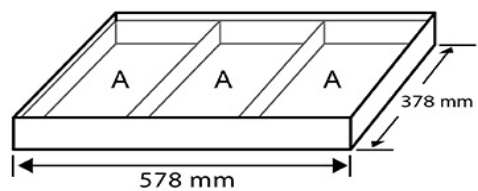
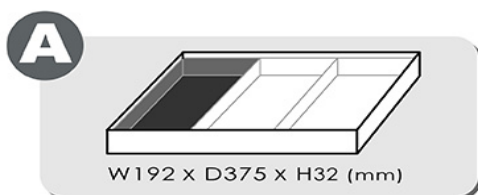



Item no.	Content / Zawartość	Size [mm]	Zam./Order
GVA0711	7	AEEC0607	6x7
		AEEC0809	8x9
		AEEC1011	10x11
		AEEC1213	12x13
		AEEC1415	14x15
		AEEC1617	16x17
		AEEC1819	18x19

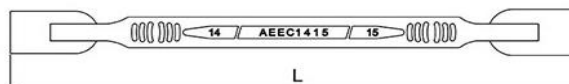
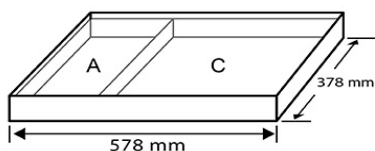
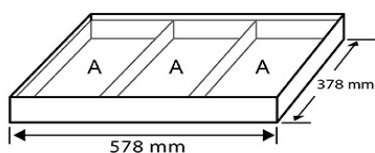
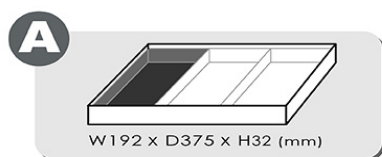
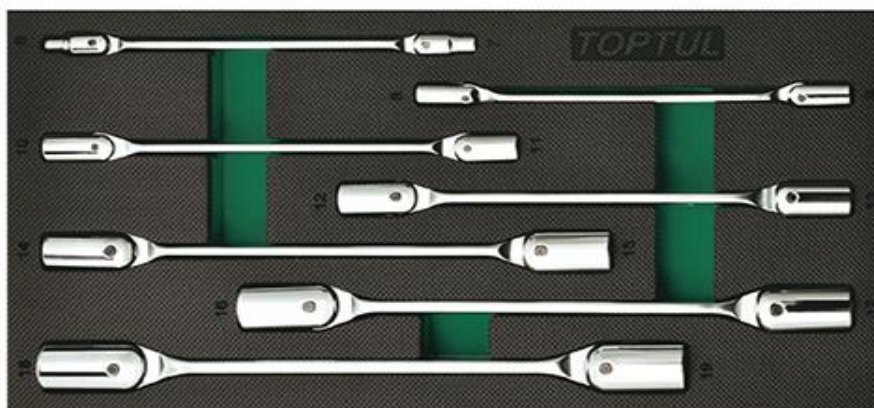

Item no.	Content / Zawartość	Size [mm]	Zam./Order
GVA0410	4	CTJA0823	8
		CTJA1023	10
		CTJA1223	12
		CTJA1323	13

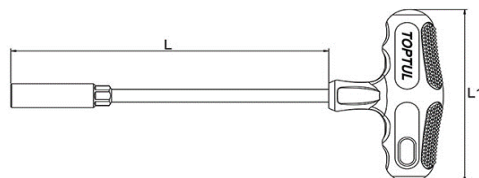
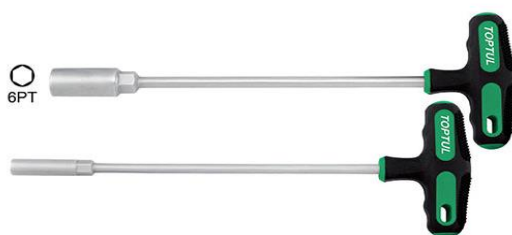
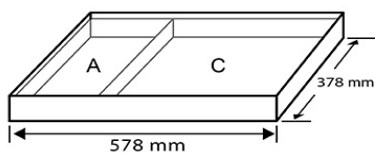
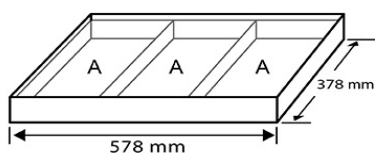
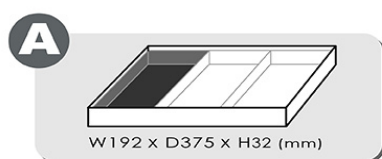



Item no.	Content / Zawartość	Size [mm]	Zam./Order
GVA0716	7	AGHD0214	2
		AGHD2E14	2.5
		AGHD0314	3
		AGHD0414	4
		AGHD0520	5
		AGHD0620	6
		AGHD0827	8

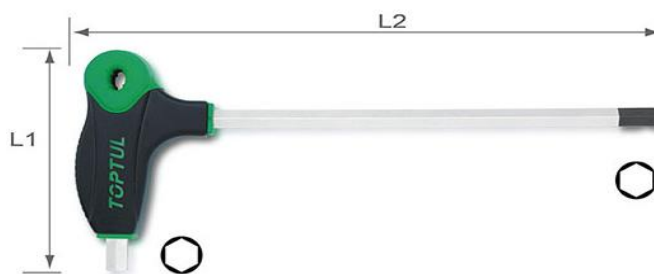
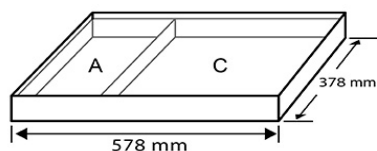
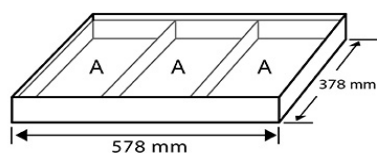
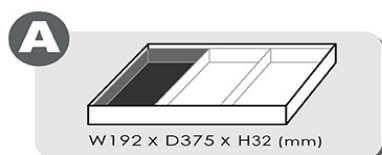



Item no.	Content / Zawartość	Size [mm]	Zam./Order
GVA0716	7	AGHD0214	2
		AGHD2E14	2.5
		AGHD0314	3
		AGHD0414	4
		AGHD0520	5
		AGHD0620	6
		AGHD0827	8

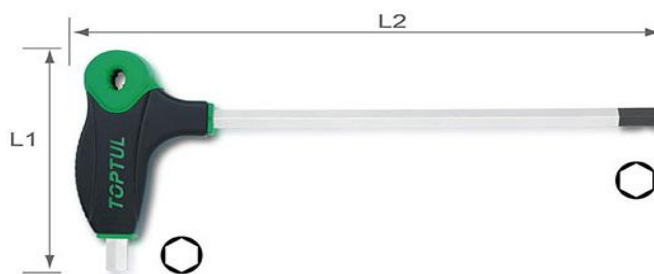
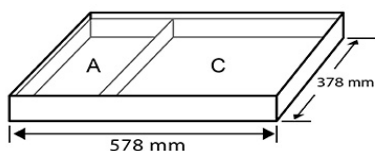
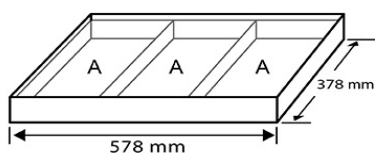
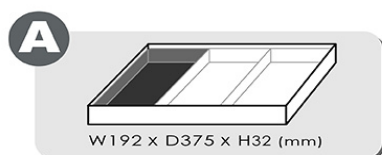

Item no.	Content / Zawartość	L
GVA0301	1 DAAQ1A10	10"
	1 DDBA2210	10"
	1 DEBB2206	6"

DDBA2210



DEBB2206

DAAQ1A10

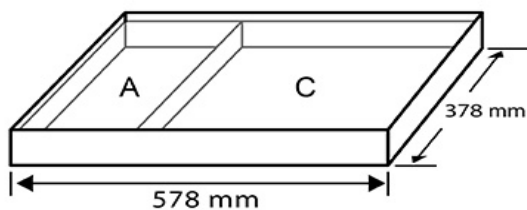
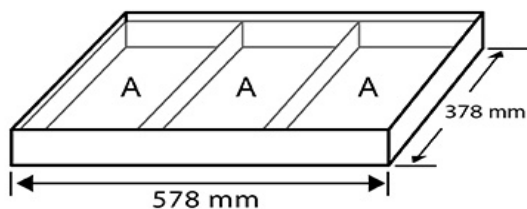
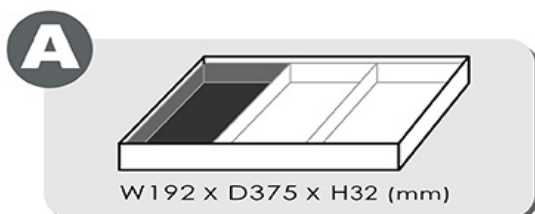



Item no.	Content / Zawiera		Size	Zam./Order
GVA0405	1	DEBC2207	Heavy Duty Diagonal Cutting Pliers - 7" (L)	
	1	DBBB2207	Combination Pliers - 7" (L)	
	1	DFBB2208	Long Nose Pliers - 8" (L)	
	1	DFBA2208	Bent Nose Pliers - 8" (L)	

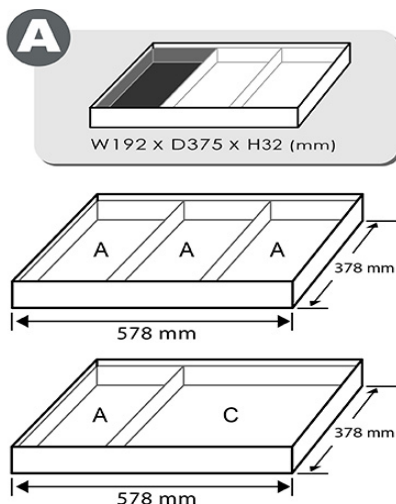
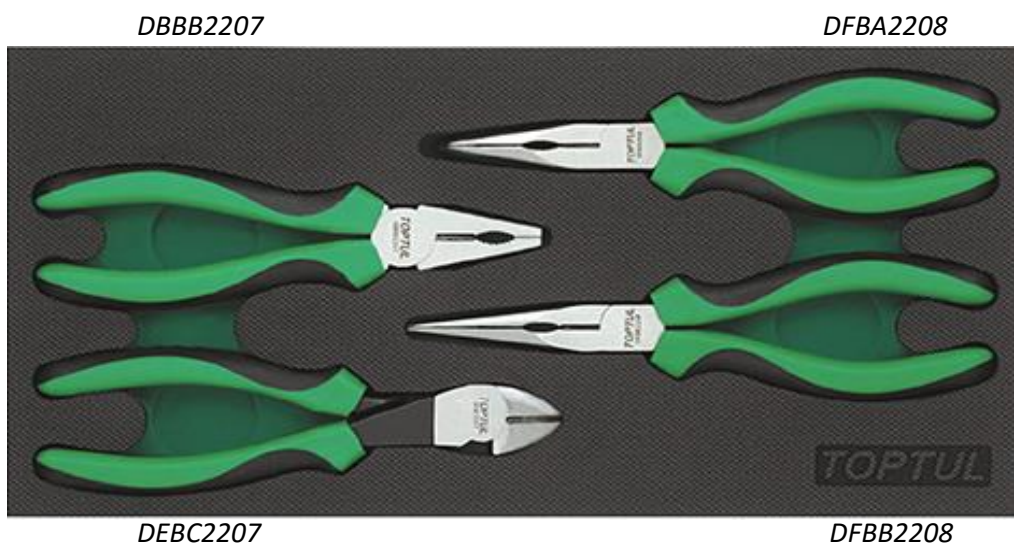



Item no.	Content / Zawiera	Size	Zam./Order
GVA0406	1 DCAA1207	90° Retaining Ring Pliers (External Ring) - 7" (L)	
	1 DCAB1207	Straight Retaining Ring Pliers (External Ring) - 7" (L)	
	1 DCAC1207	90° Retaining Ring Pliers (Internal Ring) - 7" (L)	
	1 DCAD1207	Straight Retaining Ring Pliers (Internal Ring) - 7" (L)	

DCAB1207

DCAD1207

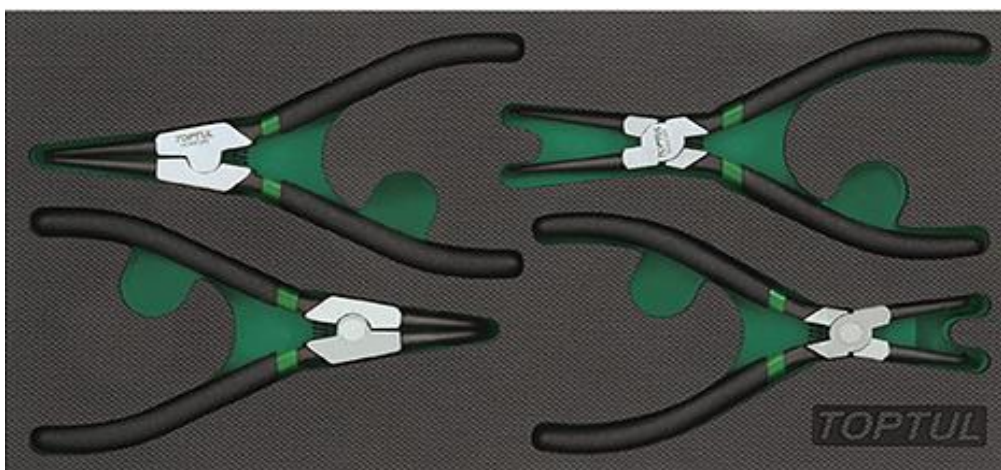

DCAA1207

DCAC1207

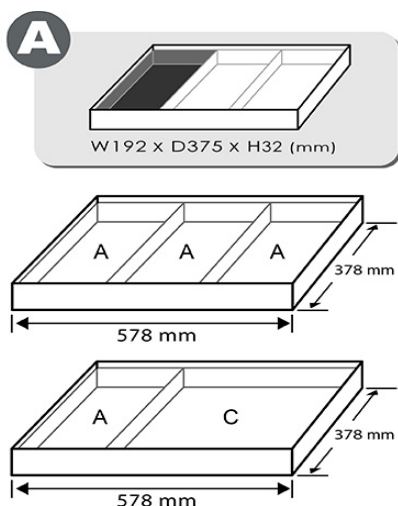



Item no.	Content / Zawartość	Size [mm]	L [mm]		Zam./Order	
GVA3002	16	BAEA1208	8	-	3/8"	
		BAEA1209	9	-	3/8"	
		BAEA1210	10	-	3/8"	
		BAEA1211	11	-	3/8"	
		BAEA1212	12	-	3/8"	
		BAEA1213	13	-	3/8"	
		BAEA1214	14	-	3/8"	
		BAEA1215	15	-	3/8"	
		BAEA1216	16	-	3/8"	
		BAEA1217	17	-	3/8"	
		BAEA1218	18	-	3/8"	
		BAEA1219	19	-	3/8"	
		BAEA1220	20	-	3/8"	
		BAEA1221	21	-	3/8"	
		BAEA1222	22	-	3/8"	
		BAEA1224	24	-	3/8"	
	7	BEAA1208	8	-	3/8"	
		BEAA1210	10	-	3/8"	
		BEAA1212	12	-	3/8"	
		BEAA1213	13	-	3/8"	
		BEAA1214	14	-	3/8"	
		BEAA1217	17	-	3/8"	
		BEAA1219	19	-	3/8"	
	3	CAAA1203	-	75	3/8"	
		CAAA1206	-	150	3/8"	
		CAAA1210	-	250	3/8"	
	1	CTCK1220	-	200	3/8"	
	1	CAHA1254	-	-	3/8"	
	1	CJBG1220	-	200	3/8"	
	1	CJHM1228	-	280	3/8"	

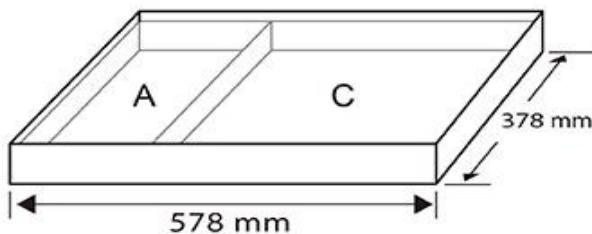
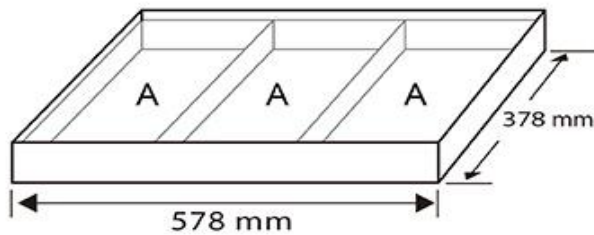

A

W192 x D375 x H32 (mm)





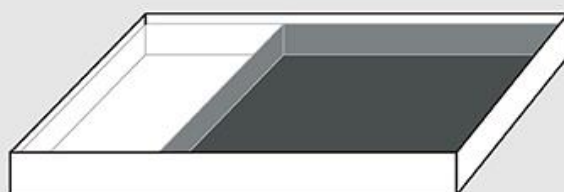





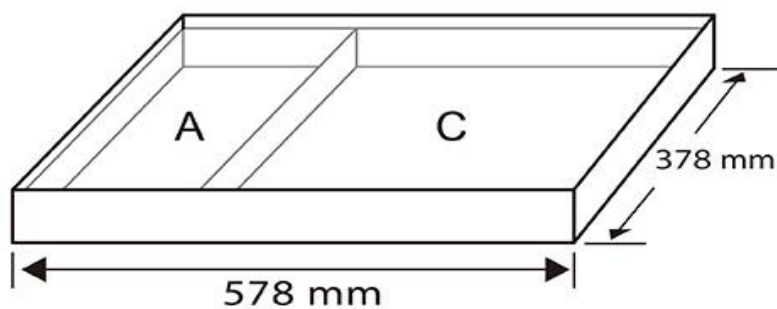

Item no.	Content / Zawartość	Size [mm]	L [mm]	Zam./Order	
GVC3903	22	BAEA1610	10	-	1/2"
		BAEA1611	11	-	1/2"
		BAEA1612	12	-	1/2"
		BAEA1613	13	-	1/2"
		BAEA1614	14	-	1/2"
		BAEA1615	15	-	1/2"
		BAEA1616	16	-	1/2"
		BAEA1617	17	-	1/2"
		BAEA1618	18	-	1/2"
		BAEA1619	19	-	1/2"
		BAEA1620	20	-	1/2"
		BAEA1621	21	-	1/2"
		BAEA1622	22	-	1/2"
		BAEA1623	23	-	1/2"
		BAEA1624	24	-	1/2"
		BAEA1625	25	-	1/2"
		BAEA1626	26	-	1/2"
		BAEA1627	27	-	1/2"
		BAEA1628	28	-	1/2"
		BAEA1629	29	-	1/2"
		BAEA1630	30	-	1/2"
		BAEA1632	32	-	1/2"
	10	BAEE1610	10	-	1/2"
		BAEE1612	12	-	1/2"
		BAEE1613	13	-	1/2"
		BAEE1614	14	-	1/2"
		BAEE1616	16	-	1/2"
		BAEE1617	17	-	1/2"
		BAEE1619	19	-	1/2"
		BAEE1621	21	-	1/2"
		BAEE1622	22	-	1/2"
		BAEE1624	24	-	1/2"
	2	BAAR1616	16	-	1/2"
		BAAR1621	21	-	1/2"
	1	CTCK1630	-	300	1/2"
	1	CAHA1678	-	-	1/2"
2	CAAA1605	-	125	1/2"	
	CAAA1610	-	250	1/2"	
1	CJBG1627	-	270	1/2"	





W383 x D375 x H32 (mm)





Item no.	Content / Zawartość	Size [mm]	L [mm]		Zam./Order	
GVC6101	4	AAEE0608	E6xE8	113	-	
		AAEE1012	E10xE12	142	-	
		AAEE1418	E14xE18	181	-	
		AAEE2024	E20xE24	224	-	
	2 	FFIB0605	T6	140	-	
		FFIB0705	T7	140	-	
	9 	FFAB0808	T8	162	-	
		FFAB0908	T9	162	-	
		FFAB1008	T10	162	-	
		FFAB1508	T15	180	-	
		FFAB2010	T20	205	-	
		FFAB2510	T25	215	-	
		FFAB2710	T27	215	-	
		FFAB3013	T30	240	-	
		FFAB4015	T40	275	-	
	5	BAED0804	E4	-	1/4"	
		BAED0805	E5	-	1/4"	
		BAED0806	E6	-	1/4"	
		BAED0807	E7	-	1/4"	
		BAED0808	E8	-	1/4"	
	4	BAED1210	E10	-	3/8"	
		BAED1211	E11	-	3/8"	
		BAED1212	E12	-	3/8"	
		BAED1214	E14	-	3/8"	
	4	BAED1616	E16	-	1/2"	
		BAED1618	E18	-	1/2"	
		BAED1620	E20	-	1/2"	
		BAED1624	E24	-	1/2"	
	6 	BCFA0810	T10	-	1/4"	
		BCFA0815	T15	-	1/4"	
		BCFA0820	T20	-	1/4"	
		BCFA0825	T25	-	1/4"	
		BCFA0827	T27	-	1/4"	
2 	BCFA0830	T30	-	1/4"		
	BCFA1240	T40	-	3/8"		
3 	BCFA1245	T45	-	3/8"		
	BCFA1650	T50	-	1/2"		
3 	BCFA1655	T55	-	1/2"		
	BCFA1660	T60	-	1/2"		
9 	GAAL0913	T10, T15, T20, T25, T27, T30, T40, T45, T50				



Item no.	Content / Zawartość	Size [mm]	L [mm]		
GVC6101	4 	FSEA0806	T6	-	1/4"
		FSEA0807	T7	-	1/4"
		FSEA0808	T8	-	1/4"
		FSEA0809	T9	-	1/4"
	7 	FSGA0810	T10	-	1/4"
		FSGA0815	T15	-	1/4"
		FSGA0820	T20	-	1/4"
		FSGA0825	T25	-	1/4"
		FSGA0827	T27	-	1/4"
		FSGA0830	T30	-	1/4"
	2	FTAB0808	1/4"	-	1/4"
		FTAB1208	3/8"	-	1/4"

Zam./Order

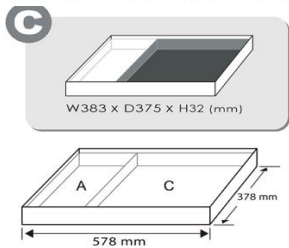

**INTER
CARS****WYPOSAŻENIE WARSZATÓW**

Item no.	Content / Zawartość	Size [mm]	L [mm]		Zam./Order	
GVA5004	13	BAEA0804	4	-	1/4"	
		BAEA084E	4,5	-	1/4"	
		BAEA0805	5	-	1/4"	
		BAEA085E	5,5	-	1/4"	
		BAEA0806	6	-	1/4"	
		BAEA0807	7	-	1/4"	
		BAEA0808	8	-	1/4"	
		BAEA0809	9	-	1/4"	
		BAEA0810	10	-	1/4"	
		BAEA0811	11	-	1/4"	
		BAEA0812	12	-	1/4"	
		BAEA0813	13	-	1/4"	
		BAEA0814	14	-	1/4"	
	8		BAEE0806	6	-	1/4"
			BAEE0807	7	-	1/4"
			BAEE0808	8	-	1/4"
			BAEE0809	9	-	1/4"
			BAEE0810	10	-	1/4"
			BAEE0811	11	-	1/4"
			BAEE0812	12	-	1/4"
	BAEE0813	13	-	1/4"		
	5		BCDA0803	3	-	1/4"
			BCDA0804	4	-	1/4"
			BCDA0805	5	-	1/4"
			BCDA0806	6	-	1/4"
			BCDA0808	8	-	1/4"
	3		BCCA0803	3	-	1/4"
			BCCA085E	5,5	-	1/4"
			BCCA0808	8	-	1/4"
	3		BCAA08P0	PH0	-	1/4"
			BCAA08P1	PH1	-	1/4"
			BCAA08P2	PH2	-	1/4"
	3		BCBA08P0	PZ0	-	1/4"
			BCBA08P1	PZ1	-	1/4"
			BCBA08P2	PZ2	-	1/4"
	1		CAIP0816	-	165	1/4"
	1		CTCK0811	-	115	1/4"
	1		CAHA0840	-	-	1/4"
	2		CAA0802	-	50	1/4"
			CAA0806	-	150	1/4"
	1		CJBM0815	-	145	1/4"
	9		GAAL0917	1,5; 2; 2,5; 3; 4; 5; 6; 8; 10		

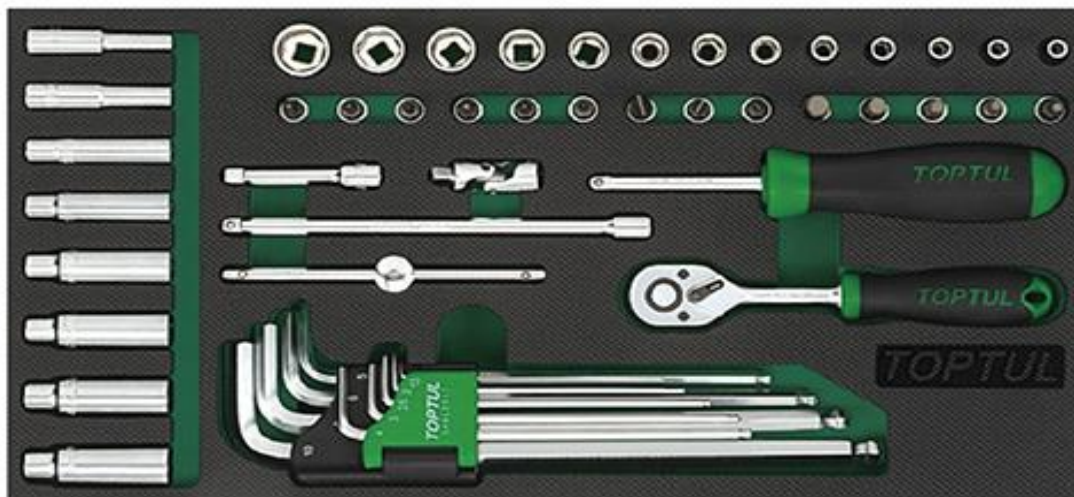





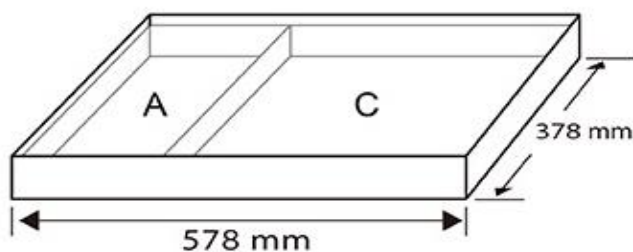
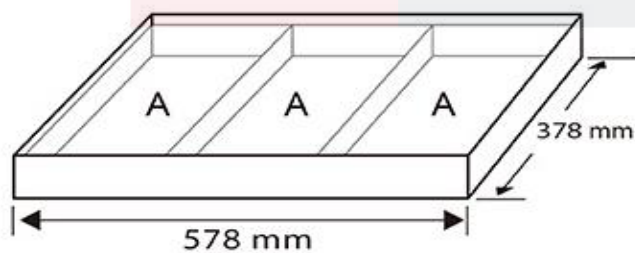

A



W192 x D375 x H32 (mm)







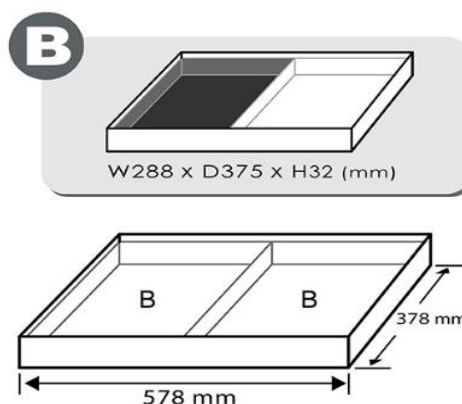



Item no.	Content / Zawiera	Size	L [mm]		Zam./Order	
GVB2503	10 	BCDA1604	4 mm	55	1/2"	
		BCDA1605	5 mm	55	1/2"	
		BCDA1606	6 mm	55	1/2"	
		BCDA1607	7 mm	55	1/2"	
		BCDA1608	8 mm	55	1/2"	
		BCDA1610	10 mm	55	1/2"	
		BCDA1612	12 mm	55	1/2"	
		BCDA1614	14 mm	55	1/2"	
		BCDA1617	17 mm	55	1/2"	
		BCDA1619	19 mm	55	1/2"	
	6 	BCFA1620	T20	55	1/2"	
		BCFA1625	T25	55	1/2"	
		BCFA1627	T27	55	1/2"	
		BCFA1630	T30	55	1/2"	
		BCFA1640	T40	55	1/2"	
		BCFA1645	T45	55	1/2"	
	3 	BCXA1650	T50	80	1/2"	
		BCXA1655	T55	80	1/2"	
		BCXA1660	T60	80	1/2"	
	1 	BCUA1670	T70	140	1/2"	
4 	BCJA1606	M6	100	1/2"		
	BCJA1608	M8	100	1/2"		
	BCJA1610	M10	100	1/2"		
	BCJA1612	M12	100	1/2"		
1 	BCJD1614	M14	100	1/2"		





Item no.	Content / Zawiera	Size	Zam./Order
GVB1202	1 	FABB6E03	6.5x25
	4 	FAAB0308	3.0x75
		FAAB3E10	3.5x10
		FAAB0410	4.0x100
		FAAB5E15	5.5x150
	1 	FAHB6E15	6.5x150
	1 	FAGB0818	8x175
	1 	FBBB0203	PH2x25
	3 	FBAB0006	PH0x60
		FBAB0108	PH1x80
		FBAB0210	PH2x100
	1 	FBHB0315	PH3x150

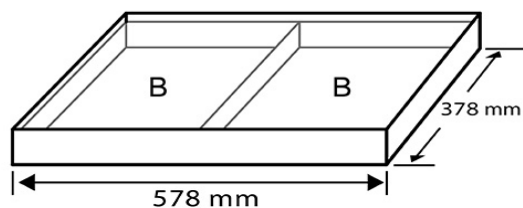
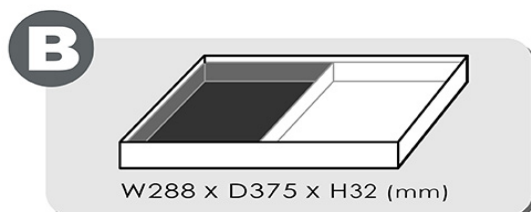



Item no.	Content / Zawiera	Size [mm]	L [mm]		
GVB0904	1	HAAA0532	27	320	500 g
	1	HAAB1038	38	290	1 lb
	4	HBBA0315	3	150	-
		HBBA0418	4	180	-
		HBBA0520	5	200	-
		HBBA0621	6	210	-
	1	HBBC0419	4	185	-
	2	HCBB1920	19	200	-
		HCBB2522	25	220	-

Zam./Order

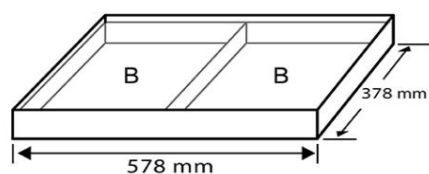
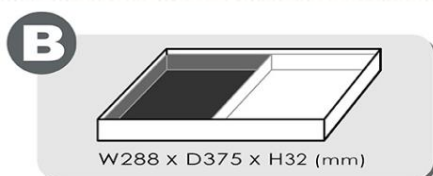



Item no.	Content / Zawartość	L	Zam./Order
GVB0701	5	SDBB0821	8"
		SDBE0815	8"
		SDBC0821	8"
		SDBA0808	8"
		SDBD0808	8"
	1	JJAJ0813	245 mm
	1	NBAA0315	Brush

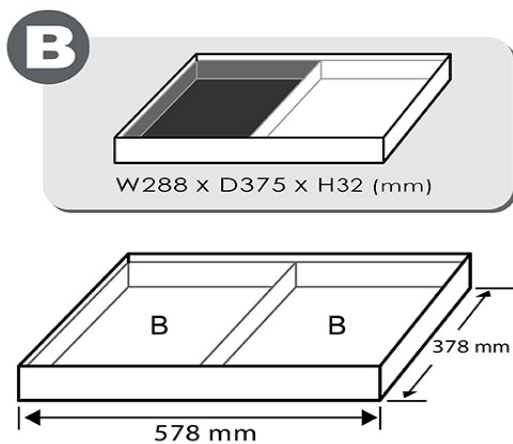



Item no.	Content / Zawartość	Size [mm]	L [mm]			Zam./Order
GVD2803	1	ANAM1620	-	500	1/2"	20-200 Nm
	1	KAAC1645	-	145	1/2"	max. 610 Nm
	3	KABC1617	17	86	1/2"	Blue
		KABC1619	19	86	1/2"	Green
		KABC1621	21	86	1/2"	Red
	24	KABA1608	8	-	1/2"	-
		KABA1609	9	-	1/2"	-
		KABA1610	10	-	1/2"	-
		KABA1611	11	-	1/2"	-
		KABA1612	12	-	1/2"	-
		KABA1613	13	-	1/2"	-
		KABA1614	14	-	1/2"	-
		KABA1615	15	-	1/2"	-
		KABA1616	16	-	1/2"	-
		KABA1617	17	-	1/2"	-
		KABA1618	18	-	1/2"	-
		KABA1619	19	-	1/2"	-
		KABA1620	20	-	1/2"	-
		KABA1621	21	-	1/2"	-
		KABA1622	22	-	1/2"	-
		KABA1623	23	-	1/2"	-
		KABA1624	24	-	1/2"	-
		KABA1625	25	-	1/2"	-
		KABA1626	26	-	1/2"	-
		KABA1627	27	-	1/2"	-
		KABA1628	28	-	1/2"	-
		KABA1629	29	-	1/2"	-
		KABA1630	30	-	1/2"	-
		KABA1632	32	-	1/2"	-
	15	KABE1610	10	78	1/2"	-
		KABE1612	12	78	1/2"	-
		KABE1613	13	78	1/2"	-
KABE1614		14	78	1/2"	-	
KABE1615		15	78	1/2"	-	
KABE1616		16	78	1/2"	-	
KABE1617		17	78	1/2"	-	
KABE1618		18	78	1/2"	-	
KABE1619		19	78	1/2"	-	
KABE1621		21	78	1/2"	-	
KABE1622		22	78	1/2"	-	
KABE1624	24	78	1/2"	-		
KABE1627	27	78	1/2"	-		



GVD4602		KABE1630	30	78	1/2"	-	
		KABE1632	32	78	1/2"	-	
	1	KACE1605	-	125	1/2"	-	
	1	KACU1606	-	-	1/2"	Joint	

D

W575 x D375 x H32 (mm)

